



GUILDFORD  
B O R O U G H

[www.guildford.gov.uk](http://www.guildford.gov.uk)

**Tom Horwood**  
Joint Chief Executive of Guildford and  
Waverley Borough Councils

Dear Councillor

**PLANNING COMMITTEE - WEDNESDAY 16 AUGUST 2023**

Please find attached the following:

**Agenda No    Item**

9.     **Presentations (Pages 1 - 88)**

Yours sincerely

Sophie Butcher, Democratic Services Officer

Encs

This page is intentionally left blank

**23/P/00473**

**Unit 3a, Kings Court  
Burrows Lane  
Gomshall, Shere,  
Guildford**

[Previous](#)

[Next](#)

[Home](#)



Location plan

[Previous](#)

[Next](#)

[Home](#)



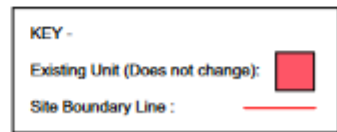
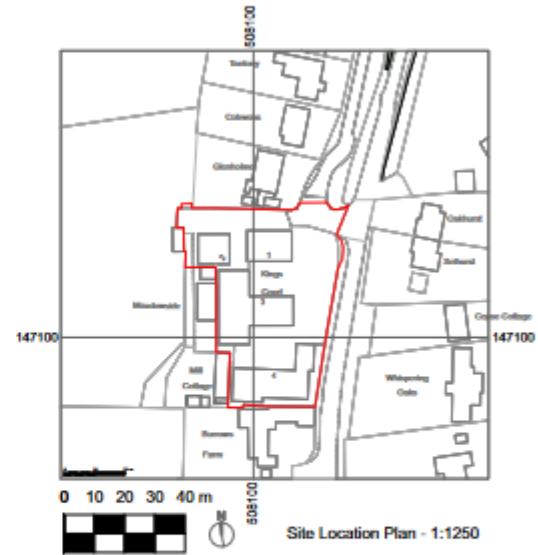
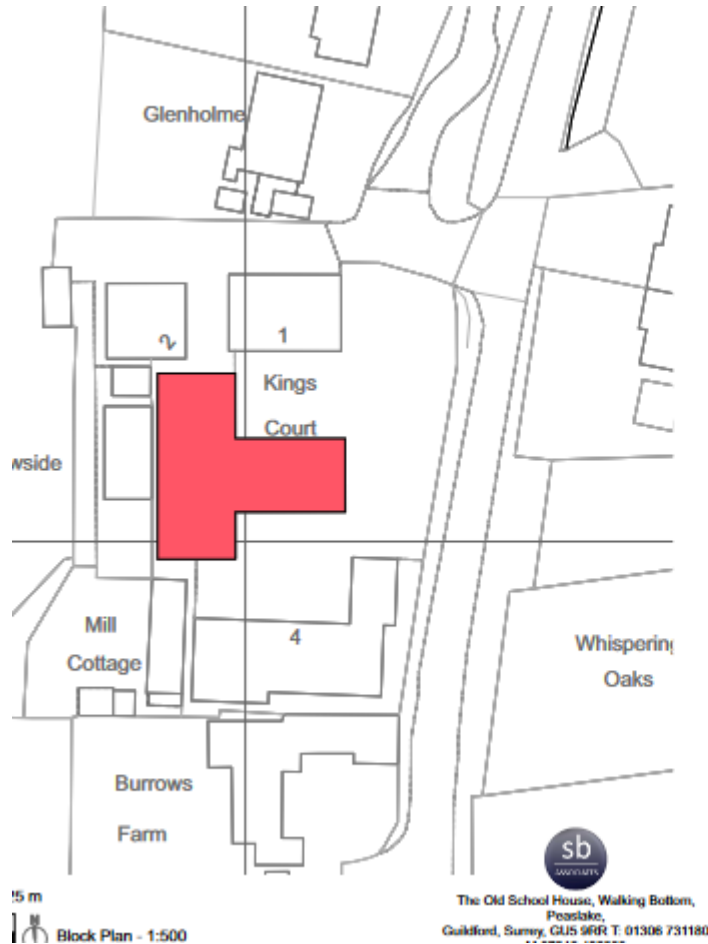

Sheet Title: Block 3 Site Location Plan  
 Client: Luke Margells  
 Address: Unit 4B, Kings Court, Burrows Lane, Gomsha Surrey, GU5 9QE

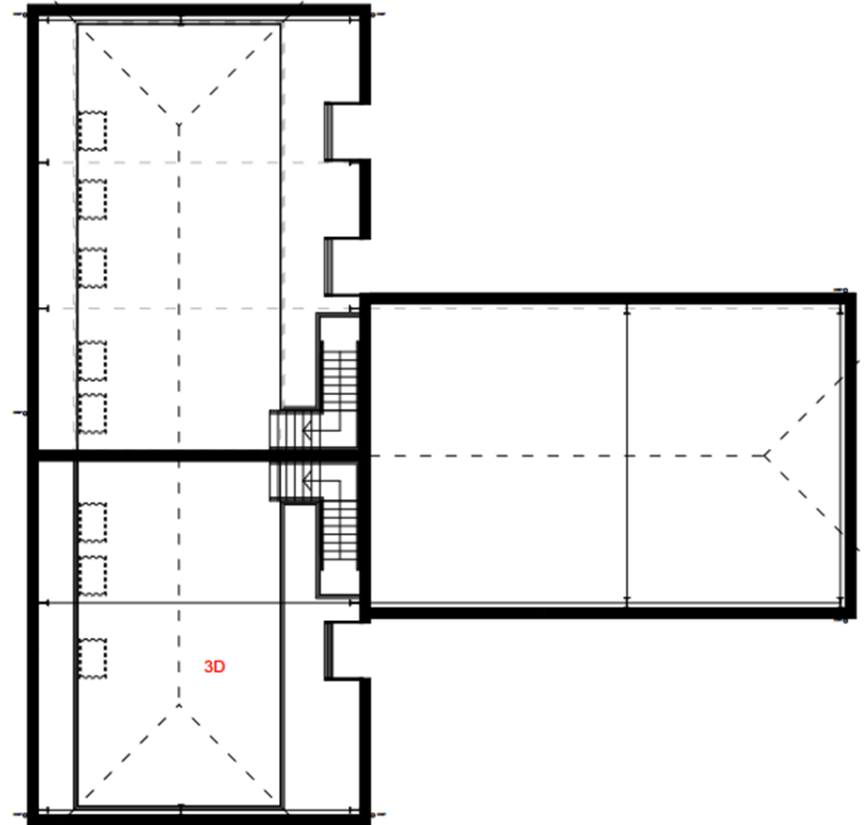
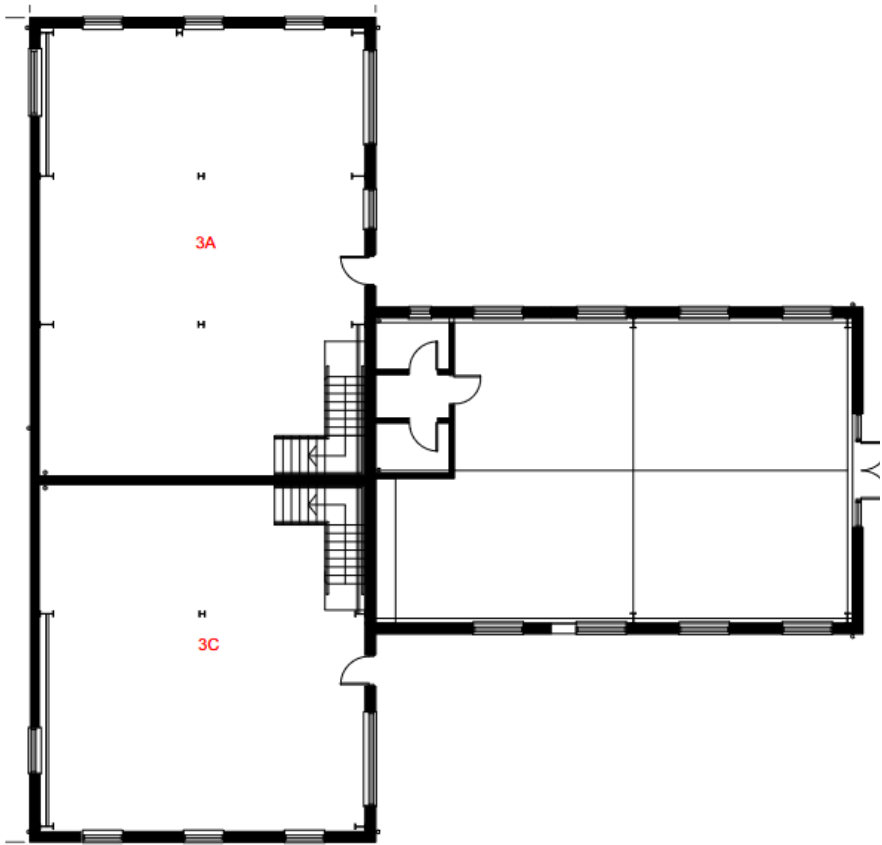

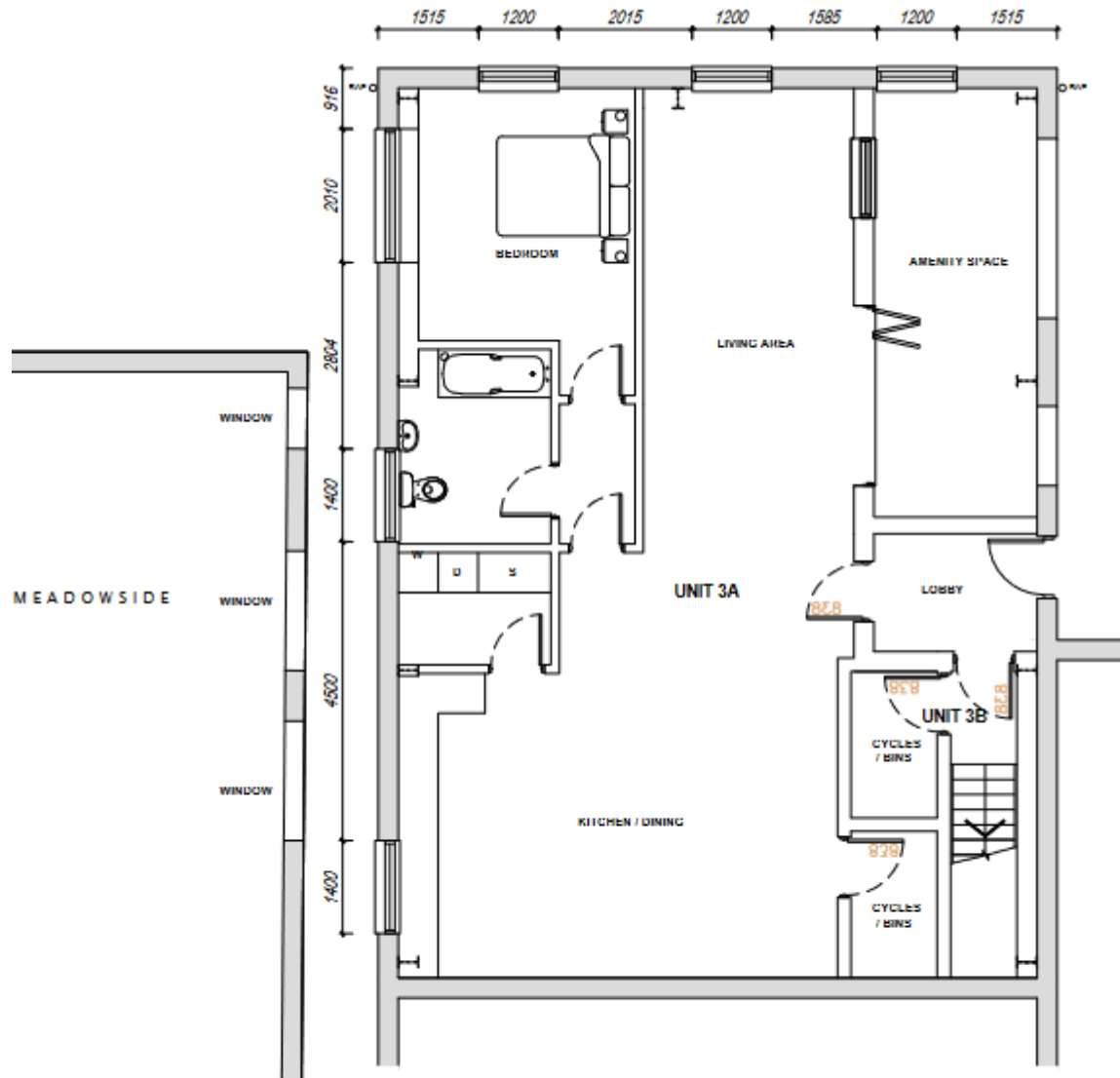

## PROPOSED GROUND FLOOR PLAN

SCALE 1:100

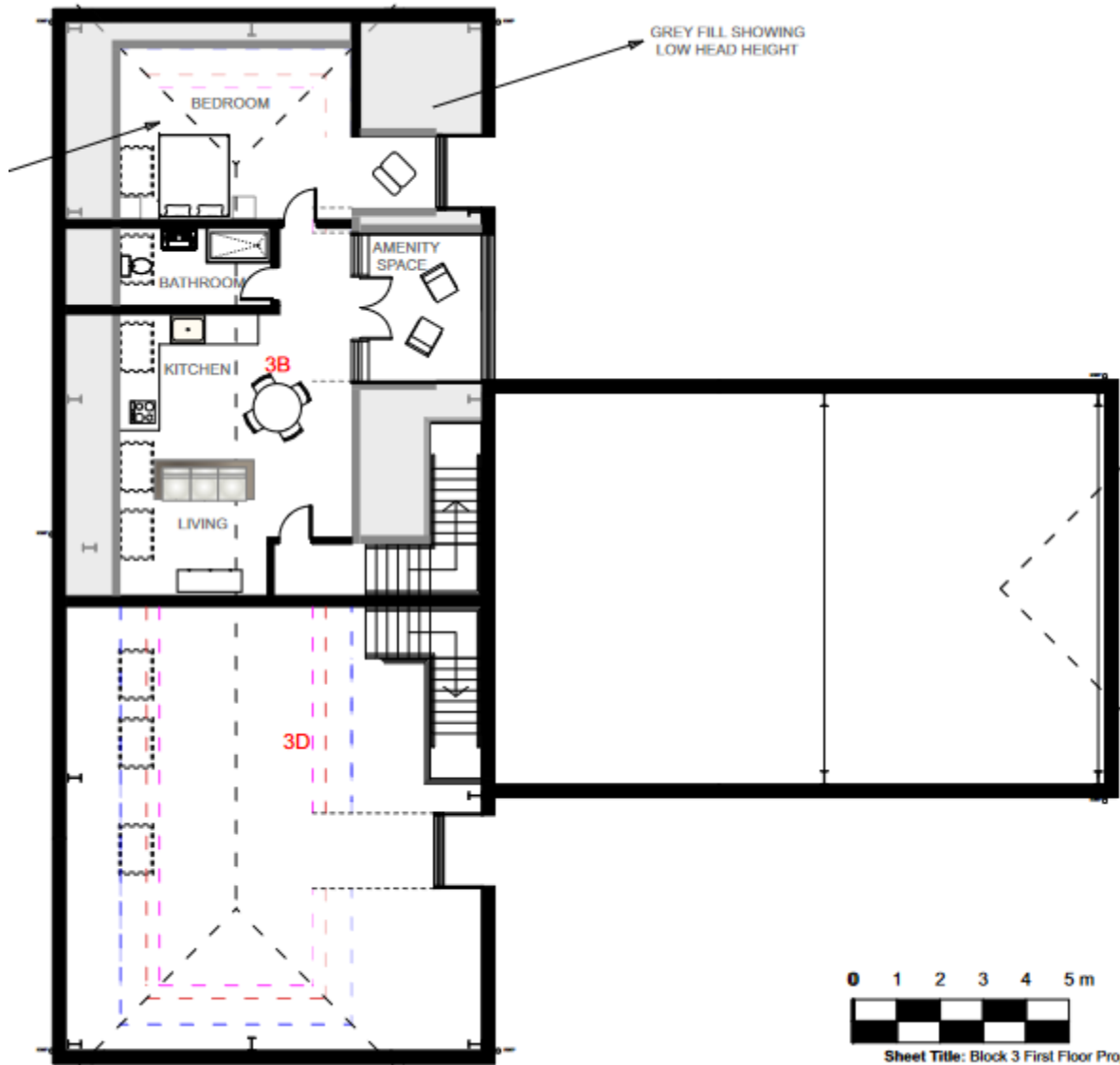

Proposed first floor plan

[Previous](#)

[Next](#)

[Home](#)

0 1 2 3 4 5 m  
 Sheet Title: Block 3 First Floor Proposed P  
 Client: Luke Margells  
 Address: Unit 4B, Kings Court, Burrows Lane, C  
 Surrey

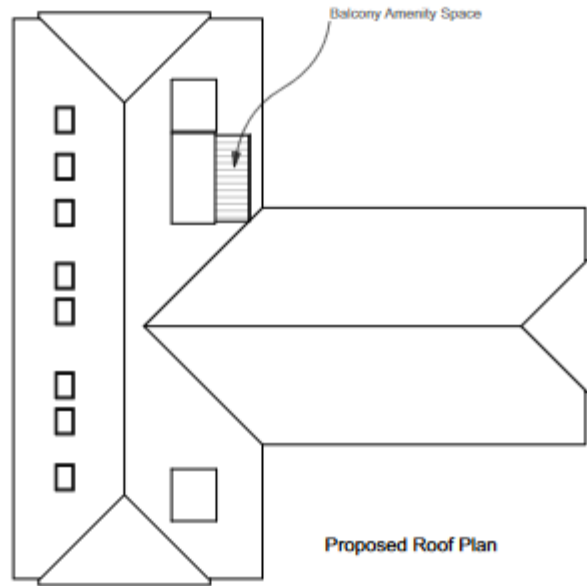
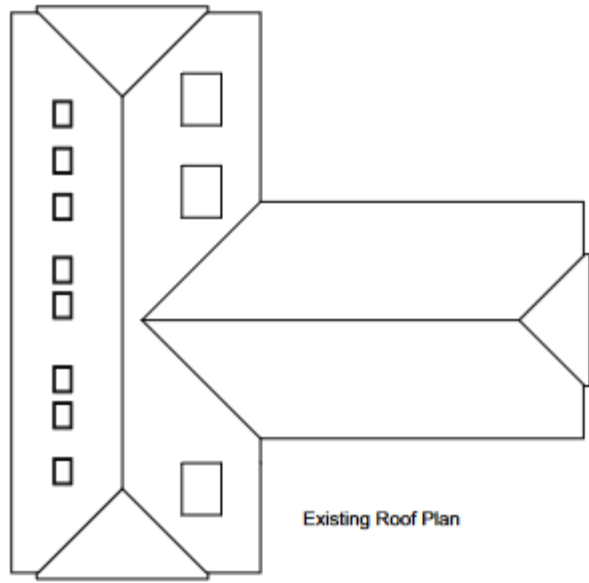

Block 3  
Existing  
Elevations

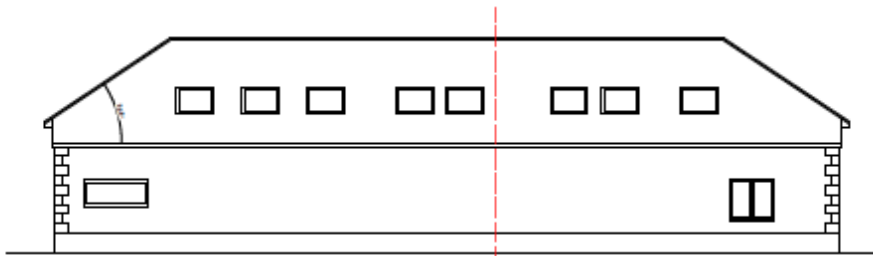
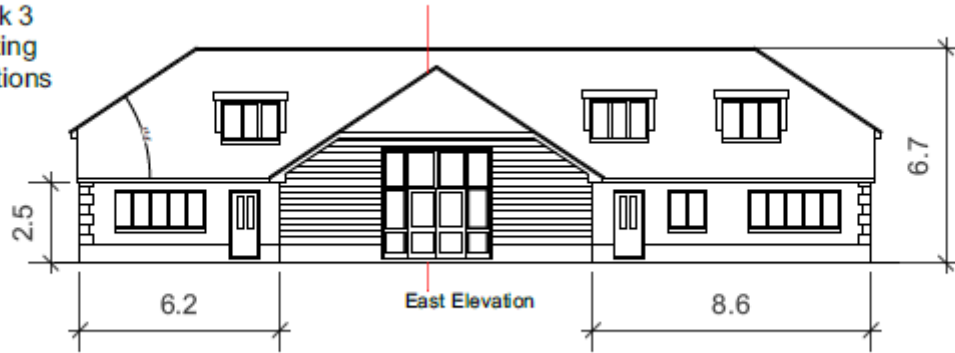

West Elevation



North Elevation

[Previous](#)

[Next](#)

[Home](#)



**PROPOSED EAST ELEVATION**  
SCALE 1:100

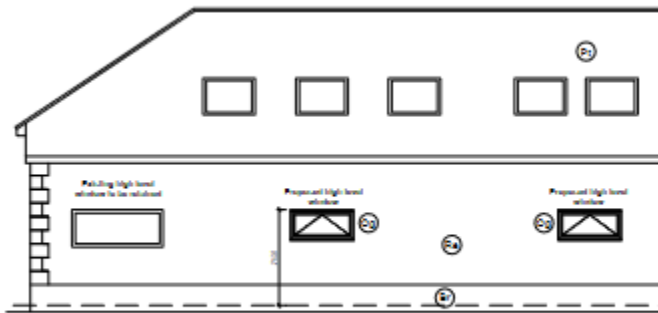

**PROPOSED WEST ELEVATION**  
SCALE 1:100



**PROPOSED NORTH ELEVATION**  
SCALE 1:100

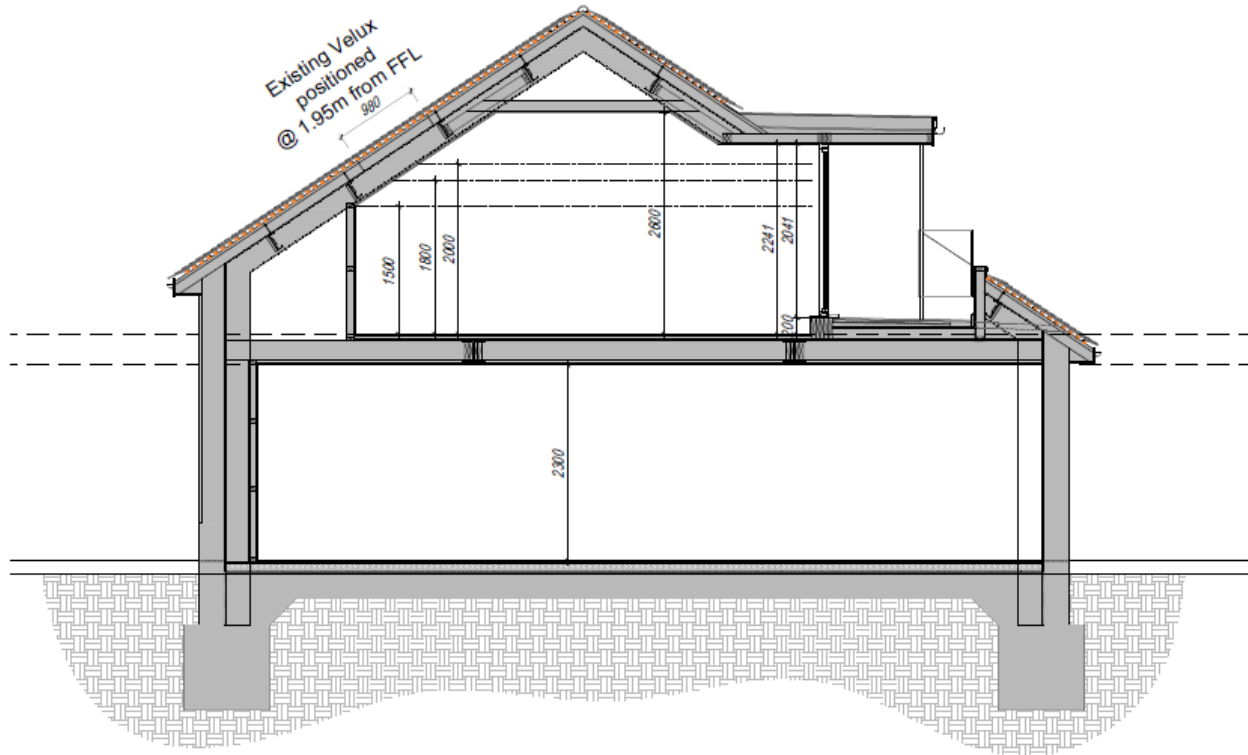

**PROPOSED SECTION UNIT 3A**

[Previous](#)

[Next](#)

[Home](#)





Simon Best Associates drawing. Simon Best Associates should be informed of any construction on site. Until full approval of both planning and building regulations has been granted all drawings are preliminary and are not for construction. Commencement of construction prior to approval being granted is entirely at his/her own risk. Drawing is Subject to Copyright ©. All drawings remain the copyright of Simon Best Associates Ltd and may not be copied or reproduced without written consent of Simon Best Associates Ltd.



The Old School House, Walking Bottom.

Sheet Title: Block Plan and Red Line Drawings

[Previous](#)

[Next](#)

[Home](#)



[Previous](#)

[Next](#)

[Home](#)

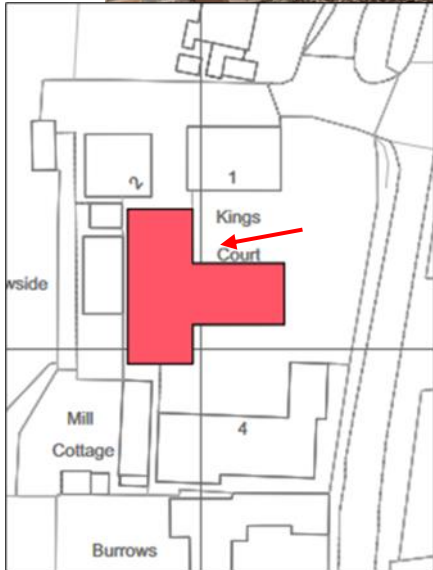

[Previous](#)

[Next](#)

[Home](#)

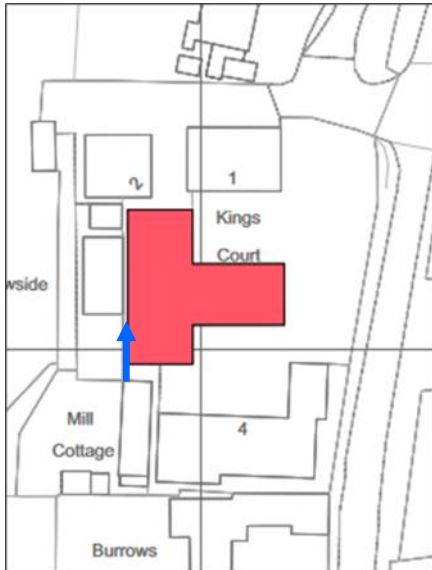

[Previous](#)

[Next](#)

[Home](#)



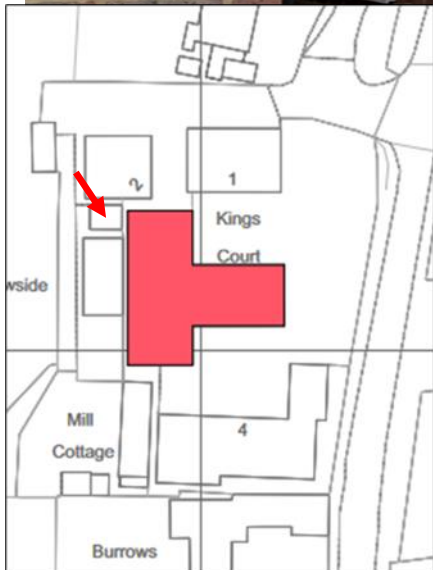

[Previous](#)

[Next](#)

[Home](#)



[Previous](#)

[Next](#)

[Home](#)





[Previous](#)

[Next](#)

[Home](#)



[Previous](#)

[Next](#)

[Home](#)



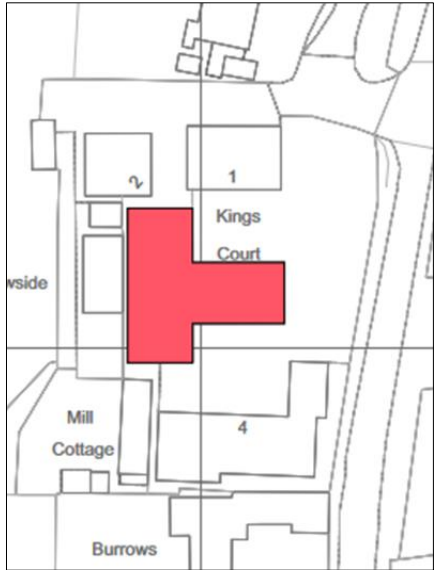

[Previous](#)

[Next](#)

[Home](#)

This page is intentionally left blank

**23/P/00606**

**Abinger Field  
Sutton Place  
Abinger Hammer  
Dorking**

[Previous](#)

[Next](#)

[Home](#)



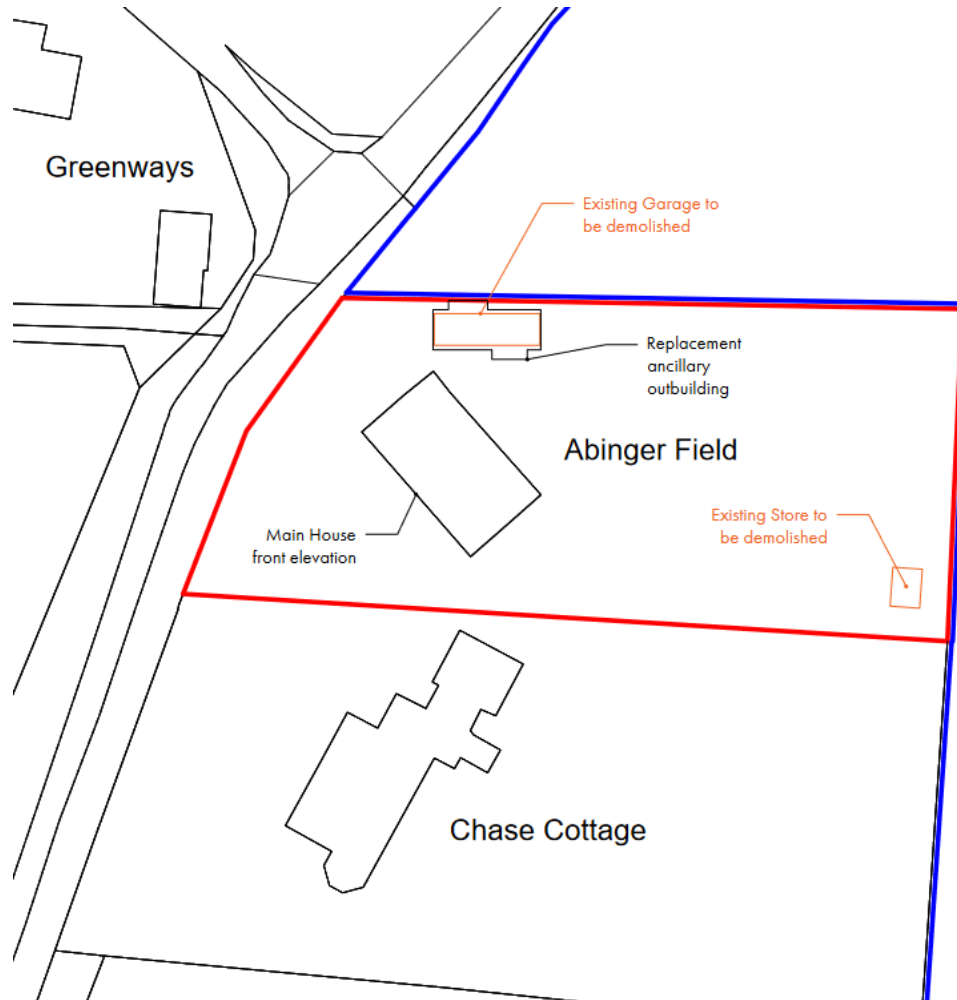

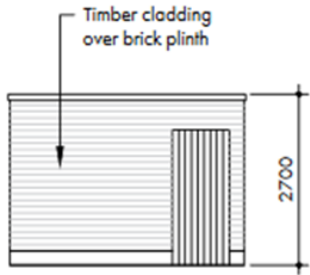

West/Front Elevation

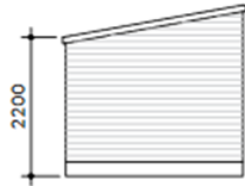

North/Side Elevation

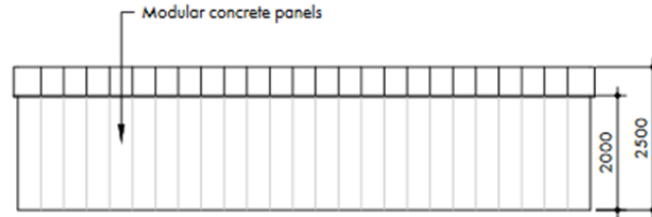

North/Side Elevation



East/Rear Elevation

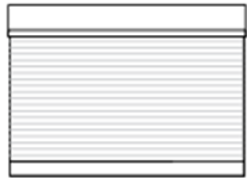

East/Rear Elevation



South/Side Elevation

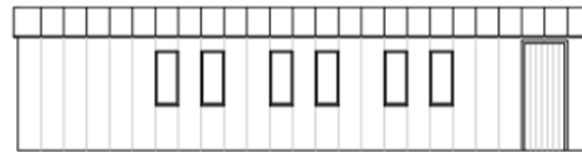

South/Side Elevation



West/Elevation

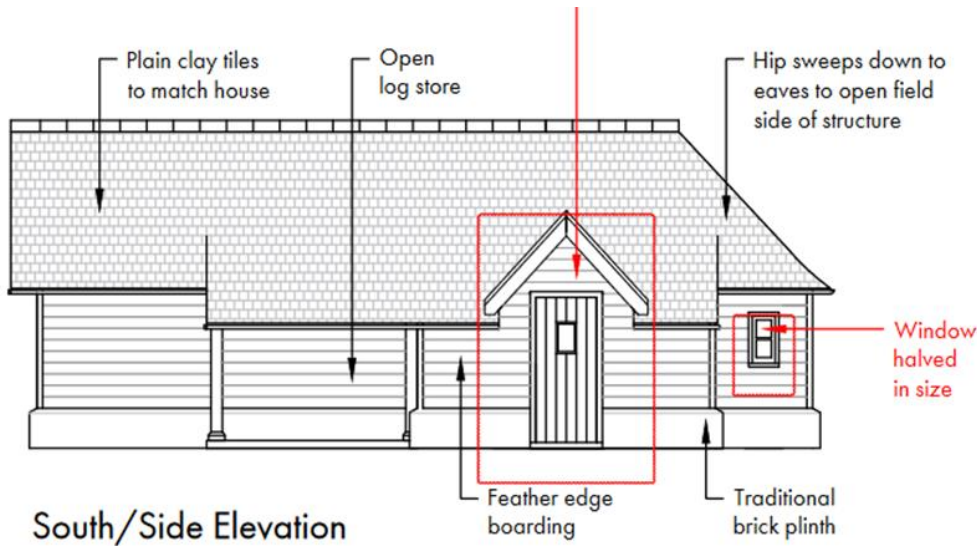

South/Side Elevation

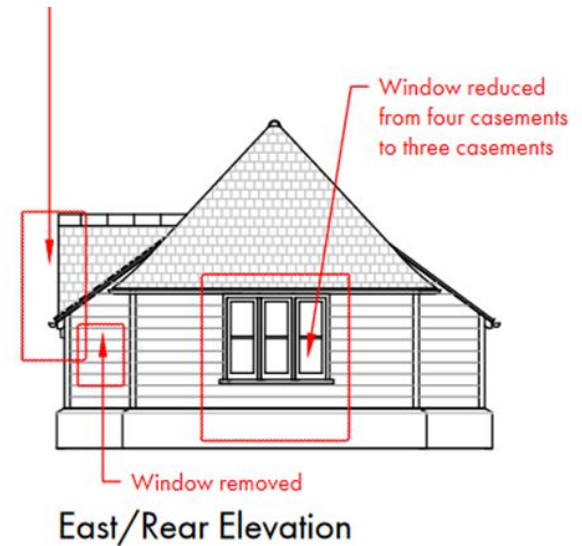

East/Rear Elevation

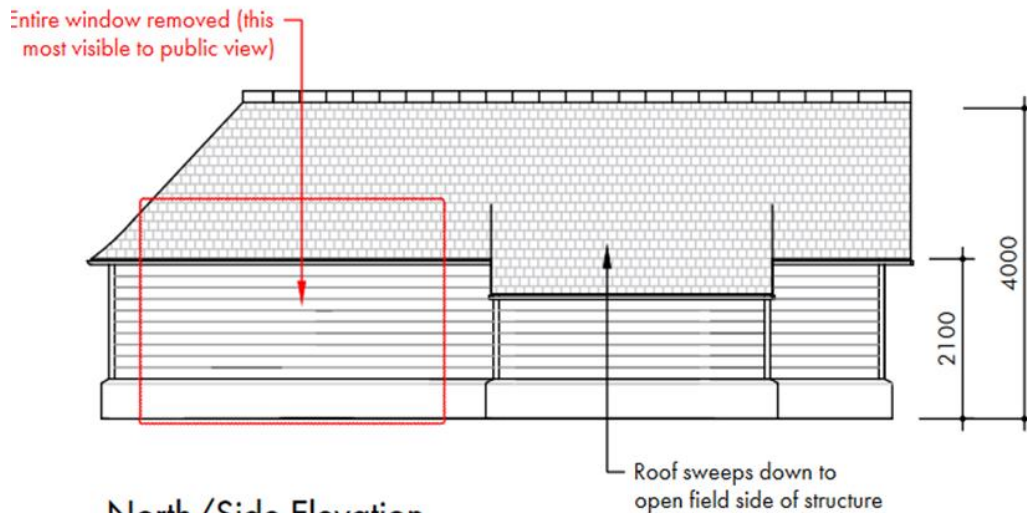

North/Side Elevation

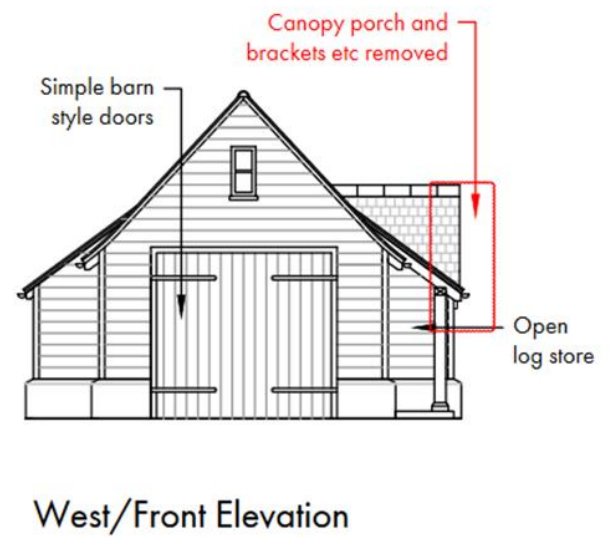

West/Front Elevation

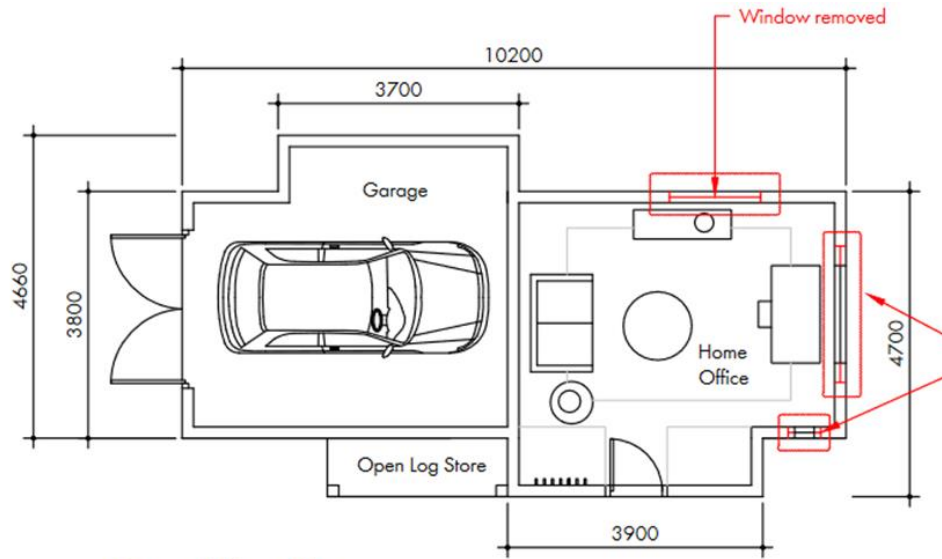

Ground Floor Plan

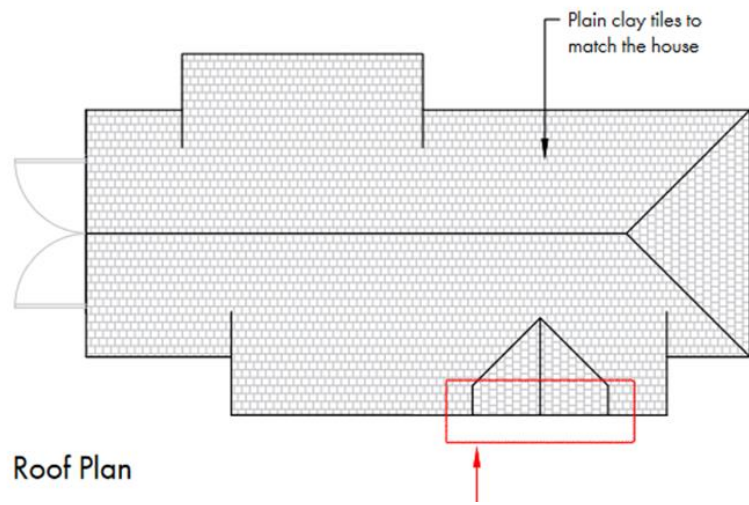

Roof Plan



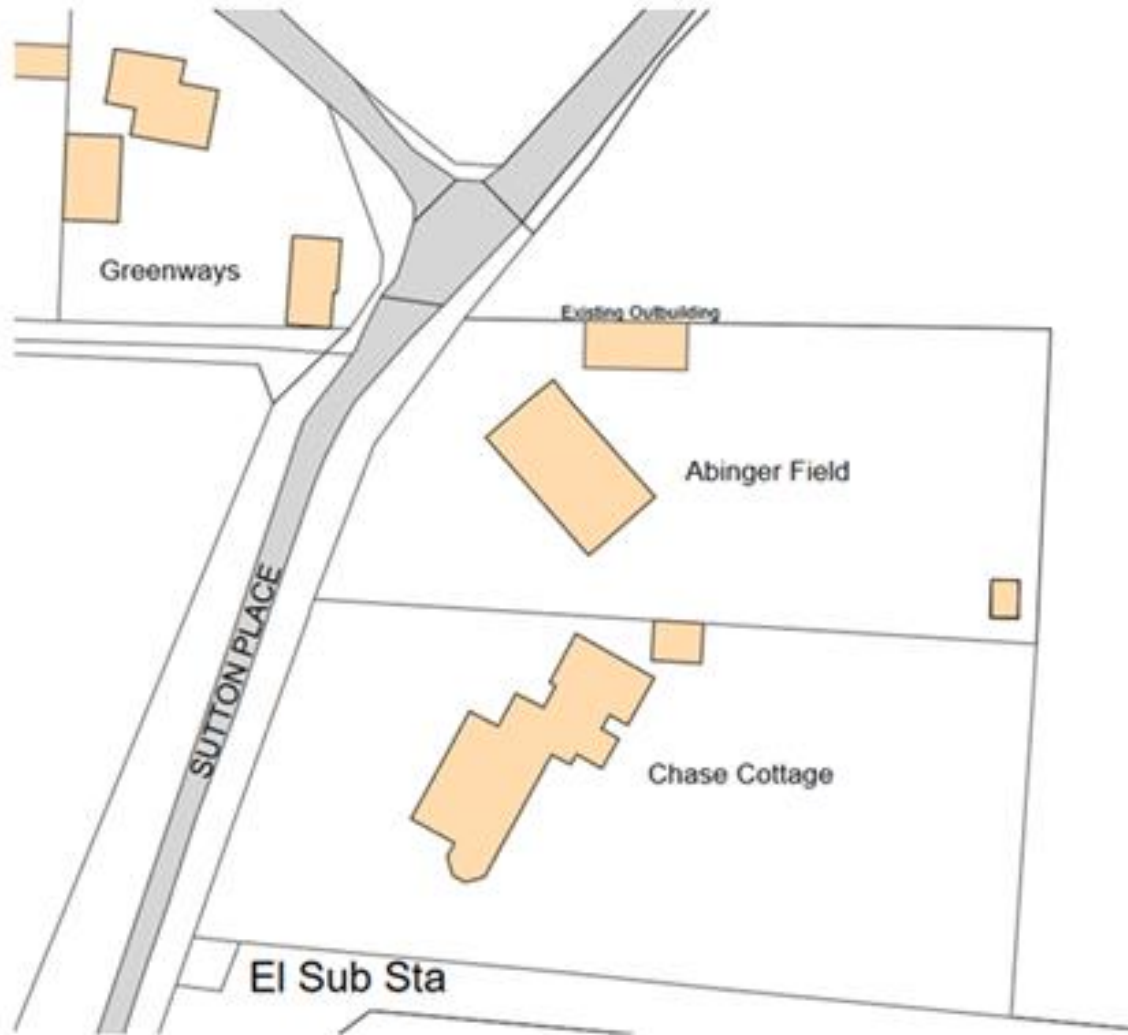

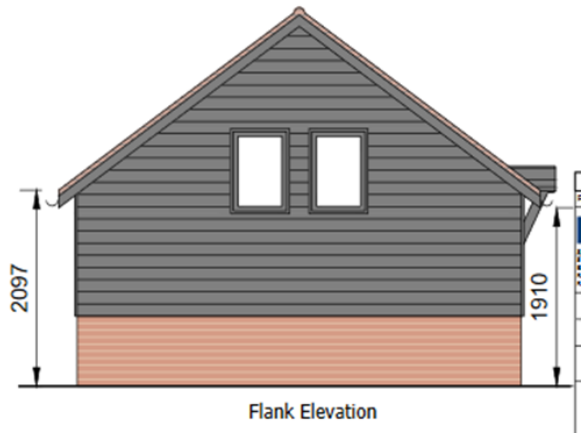
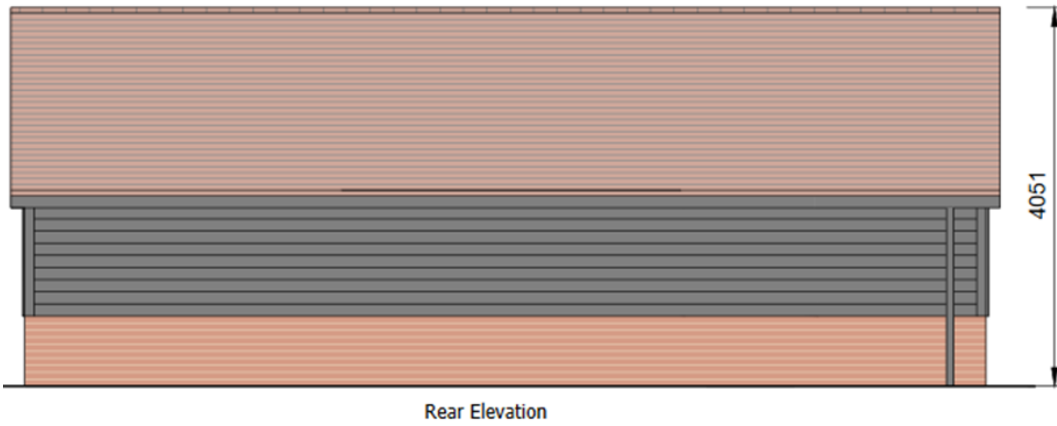
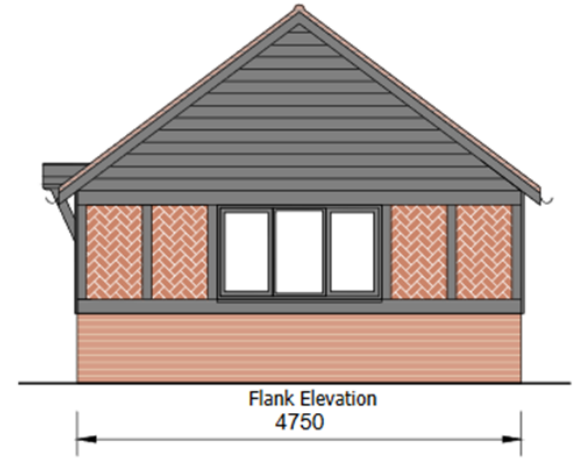
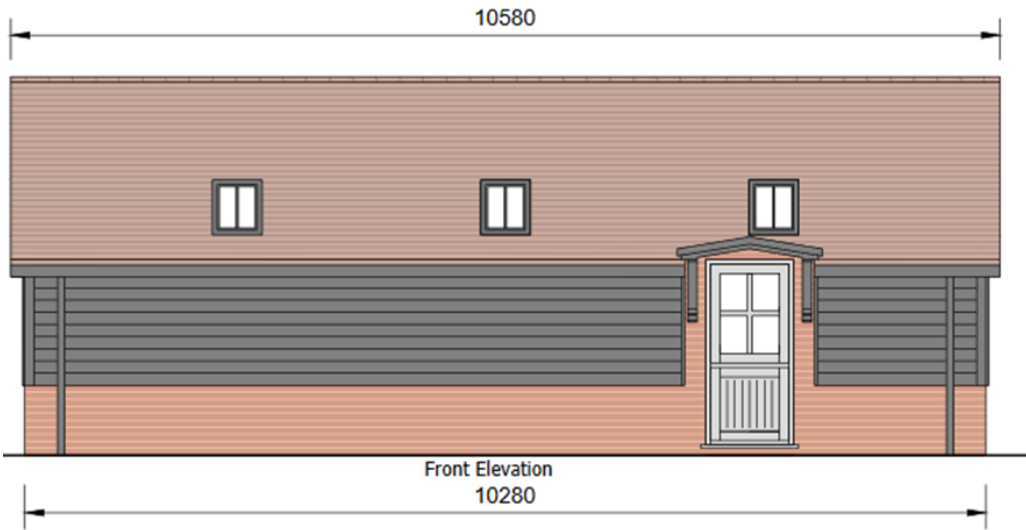

Existing elevations

[Previous](#)

[Next](#)

[Home](#)

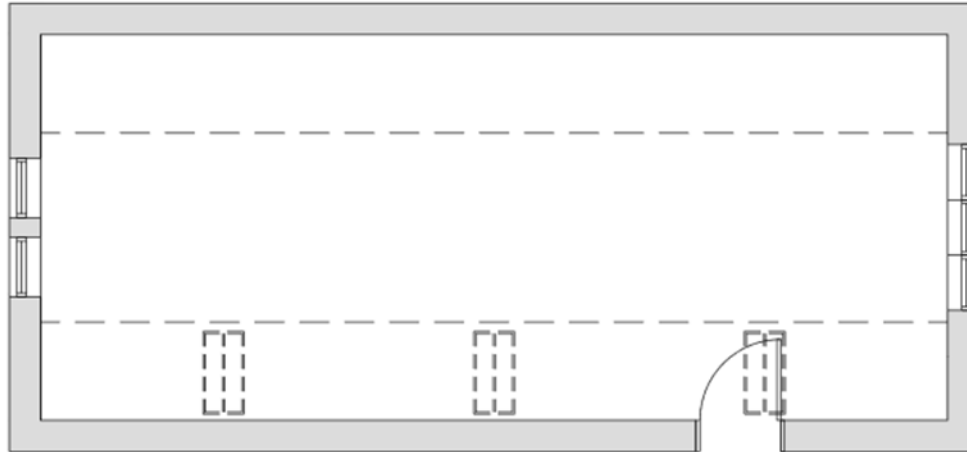

Outbuilding/ Storage Floor Plan



Outbuilding/ Storage Roof Plan



[Previous](#)

[Next](#)

[Home](#)



[Previous](#)

[Next](#)

[Home](#)



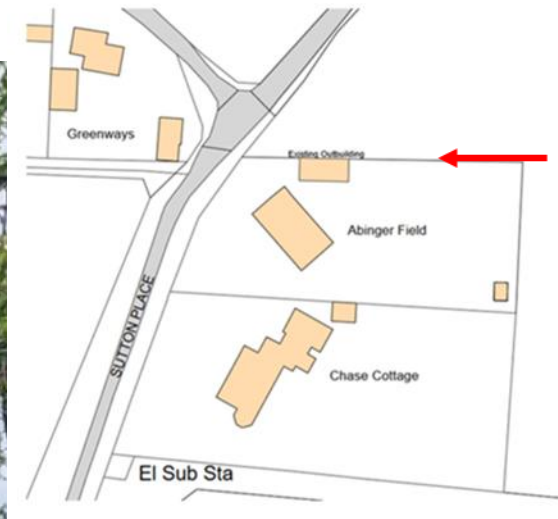

[Previous](#)

[Next](#)

[Home](#)





[Previous](#)

[Next](#)

[Home](#)



[Previous](#)

[Next](#)

[Home](#)



**21/P/01211**

**Land at May and Juniper Cottages**

**Ash Green Road**

**Ash**

**GU12 6JH**

(16 August 2023)

[Previous](#)

[Next](#)

[Home](#)



## Site Location Plan

[Previous](#)

[Next](#)

[Home](#)



**Aerial View**

**Previous**

**Next**

**Home**





**Site photo: Entrance off Ash Green Road**

[Previous](#)

[Next](#)

[Home](#)





**Site photo: SE towards May & Juniper cottages**

[Previous](#)

[Next](#)

[Home](#)



**Site photo: South-facing towards cottages**

[Previous](#)

[Next](#)

[Home](#)





**Site photo: Ancient Woodlands**

[Previous](#)

[Next](#)

[Home](#)



Site photo: NE along railway line

[Previous](#)

[Next](#)

[Home](#)





**Site photo: Western boundary**

[Previous](#)

[Next](#)

[Home](#)





**Site photo: Site barns**

[Previous](#)

[Next](#)

[Home](#)



**Site photo: North along Ash Green Road**

[Previous](#)

[Next](#)

[Home](#)





**Site photo: South along Ash Green Road**

[Previous](#)

[Next](#)

[Home](#)



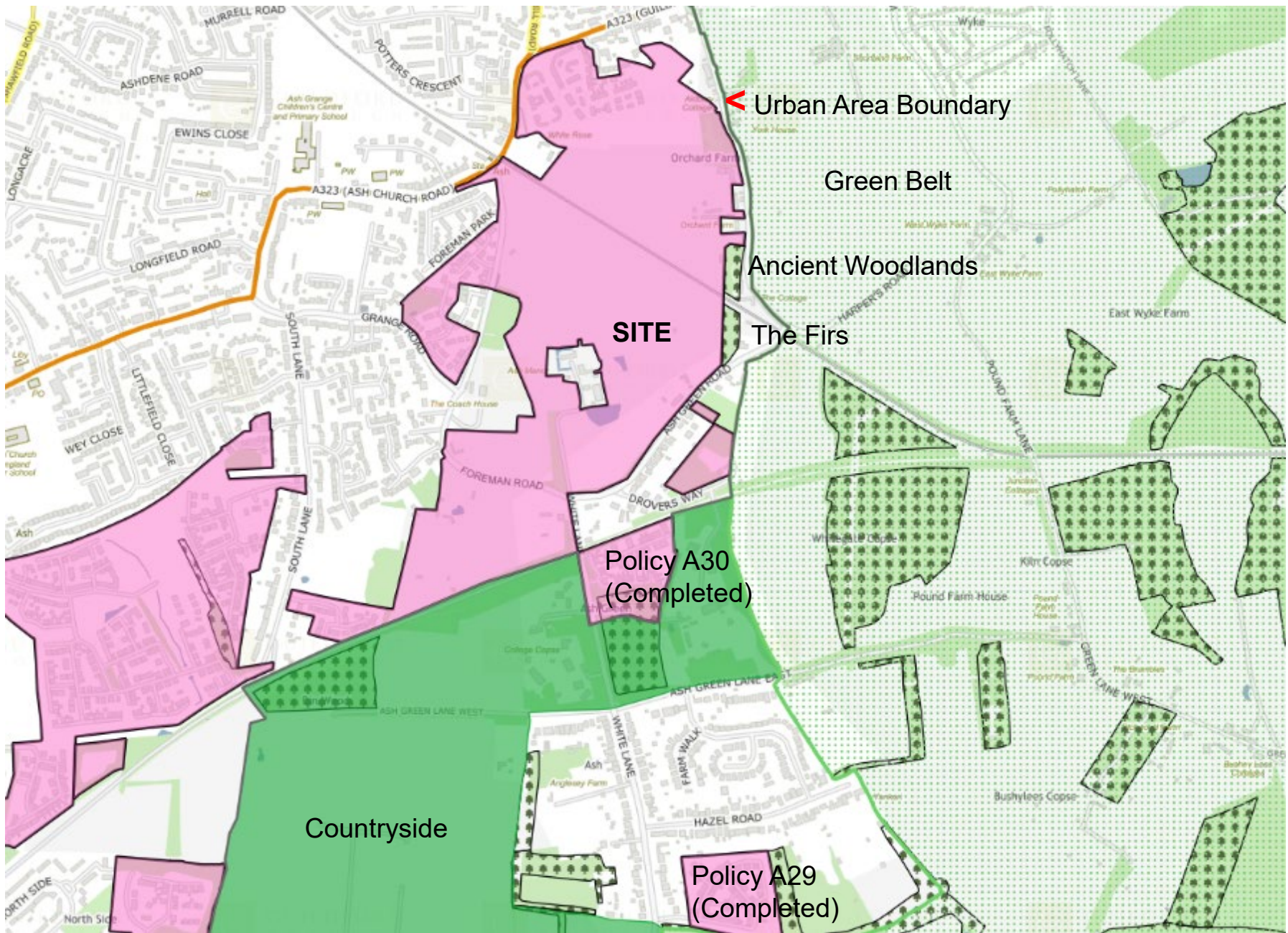



















Site constraints and opportunities

[Previous](#)

[Next](#)

[Home](#)

-  Site boundary
-  Development area
-  Open space
-  Existing buildings
-  Enclosed public spaces
-  On-site primary routes
-  Access to development areas
-  Key off-site routes
-  New roundabout
-  Access to Ash Manor only
-  Key pedestrian and cycle routes / PRoW
-  Ash Road bridge
-  Railway line
-  Railway station
-  Existing gypsy and traveller's site
-  Water bodies
-  Provision of flood compensation land (area subject to detailed assessment)
-  Allocated land not included in study area
-  Possible access





# 18/P/02308 Outline Application

**Date of Decision:** 18/02/2020

(Officer Report pg.35)

In addition to a number of conditions relating to access to the site, there are also a number of other conditions on the outline permission which have dealt with other matters of principle which require:

- full details of the children's play space (LEAP)
- foul water drainage strategy
- surface water drainage strategy
- sustainability measures of individual homes
- water efficiency
- site levels and finished floor levels
- a Construction Transport Management Plan
- a scheme for parking and turning of vehicles
- a scheme for electric vehicle charging points
- a Travel Plan
- a programme of archaeological work in accordance with a Written Scheme of Investigation

These matters are not for consideration as part of this application. The assessment of details submitted under planning conditions are dealt with under delegated authority.

The outline application was also subject to a planning obligation which secured:

- affordable housing
- appropriate SANG mitigation and contributions towards SAMM
- a recreational open space contribution
- a healthcare contribution
- an education contribution
- highways improvements
- a footbridge contribution
- a public art contribution
- a road bridge scheme contribution
- restriction on the access onto Ash Green Road following

There is no requirement for a legal agreement for this reserved matters application.

The relevant considerations in respect of this application are whether the layout, scale, appearance and landscaping of the development is acceptable in planning terms. These aspects of the proposal will be assessed below.

[Previous](#)

[Next](#)

[Home](#)

S	Attitude via aerial	27.00.02	01	028
F	Local approval to signage to clients comments	28.00.03	06	011
F.1	Unrestricted Parking spaces to clients comments	28.00.03	02.06	011
F.2	Further amendments to environmental services and client comments, Pumping station main underground base - Amendments by The Design team	28.00.03	06.09	011
F.3	By 20/03/2020 to 01/04/2020 to continue unapproved parking spaces to clients comments	27.00.02	03.08	011



## Matter 1 (Layout)

[Previous](#)

[Next](#)

[Home](#)





**Matter 1 (Layout):  
Location of affordable housing**

[Previous](#)

[Next](#)

[Home](#)



**Matter 1 (Layout):  
Parking proposal**

[Previous](#)

[Next](#)

[Home](#)



Section A-A  
scale 1:200



**Matter 2 (Scale & Appearance):  
Street scene A-A**



Section C-C  
Scale 1:200



## Matter 2 (Scale & Appearance): Street scenes B-B and C-C

Previous

Next

Home





STREET SCENE: PLOTS 11-16

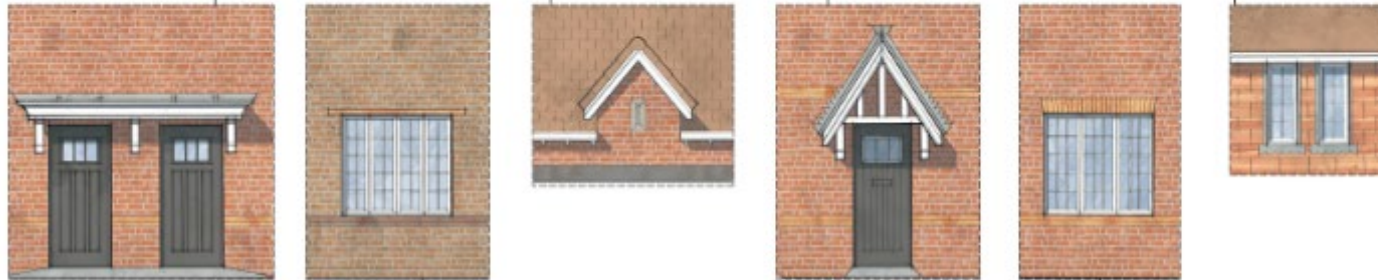

**Matter 2 (Scale & Appearance):  
Plots 11 – 16 and 23 - 27**

[Previous](#)

[Next](#)

[Home](#)



STREET SCENE EXTRACT: PLOTS 77-79



STREET SCENE EXTRACT: PLOTS 82-85



**Matter 2 (Scale & Appearance):  
Plots 77 – 79 and 82 - 85**

[Previous](#)

[Next](#)

[Home](#)





**Matter 3 (Landscaping):  
Tree protection plan and strategy**

[Previous](#)

[Next](#)

[Home](#)

# 21/P/01211 Reserved Matters Application

**July Planning Committee**  
(Officer Report pg.58)

‘In addition, it is acknowledged that the proposal fails to provide a full 'green buffer' between the development and Ash Green Road. While the proposal is therefore technically in conflict with policy A31 of the LPSS, Officers have not identified any material harm which would arise from this situation. As such, **modest weight** is also afforded to this matter’

Modest or Significant Weight

**Matter 3 (Landscaping):  
Deferred and purpose of site visit**

[Previous](#)

[Next](#)

[Home](#)





**Matter 3 (Landscaping):**  
**Policy A31(6): Green buffer/ impact**

[Previous](#)

[Next](#)

[Home](#)



**Matter 3 (Landscaping):  
Policy A31(6): Green Buffer – rear gardens**

[Previous](#)

[Next](#)

[Home](#)





**Matter 3 (Landscaping):**  
**Policy A31(6): Green Buffer/ Screening**

[Previous](#)

[Next](#)

[Home](#)



Section A-A

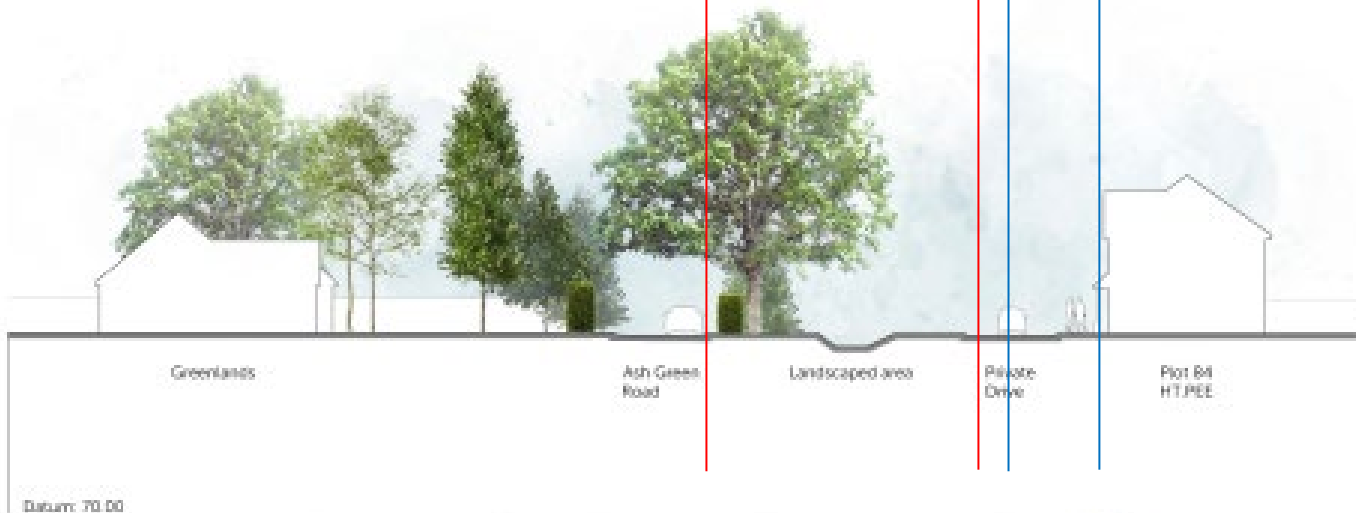

Section B-B



### Matter 3 (Landscaping): Policy A31(6): Green Buffer – Ash Green Road

[Previous](#)

[Next](#)

[Home](#)





**Matter 3 (Landscaping):  
Policy A31(6): Green Buffer/ Separation**

[Previous](#)

[Next](#)

[Home](#)





**Computer Generated Image**

[Previous](#)

[Next](#)

[Home](#)





**Computer Generated Image: Play park**

[Previous](#)

[Next](#)

[Home](#)





**Computer Generated Image: Village Green**

[Previous](#)

[Next](#)

[Home](#)







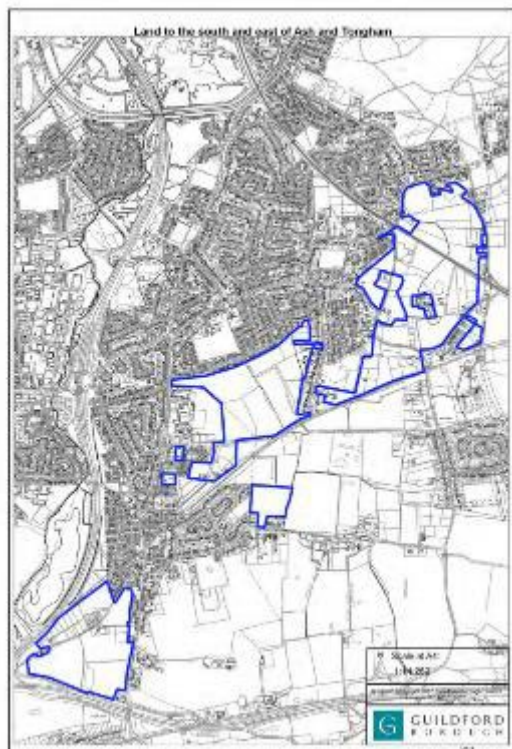

### POLICY A31: Land to the south and east of Ash and Tongham

Allocation	This is a strategic location for development. The site is allocated for approximately 1,750 homes, including some self-build and custom house building plots (C3)
Requirements	<ol style="list-style-type: none"> <li>(1) Appropriate financial contributions to enable expansion of Ash Manor Secondary School by additional 1FE</li> <li>(2) Appropriate financial contributions towards expansion of existing GP provision in the area or land and a new building for a new GP's surgery</li> <li>(3) Ensure that sufficient capacity is available within Ash Vale wastewater treatment works to accept wastewater from this development within its permitted limits</li> <li>(4) Appropriate surface water flooding mitigation measures, with specific regard to the Ash Surface Water Study</li> <li>(5) Where likely to produce positive outcomes, and it is reasonable to do so, work with landowners of nearby development sites to help reduce surface water flooding in the local area</li> <li>(6) Development proposals in the vicinity of Ash Green to have recognition of the historic location of Ash Green village. The properties along Ash Green Road form part of Ash Green village. Proposals for the land west of this road must respect the historical context of this area by preventing the coalescence of Ash, Tongham and Ash Green. Any development as a whole will not be of a size and scale that would detract from the character of the rural landscape. This must include the provision of a green buffer that maintains separation between any proposed new development and the properties fronting onto Ash Green Road. This will also help soften the edges of the strategic development location and provide a transition between the built up area and the countryside beyond</li> <li>(7) Sensitive design at site boundaries that has regard to the transition from urban to rural</li> <li>(8) Sensitive design at site boundaries with the adjacent complex of listed buildings at Ash Manor. Views to and from this heritage asset, including their approach from White Lane, must be protected</li> <li>(9) Land and provision of a new road bridge which will form part of the A323 Guildford Road, with an associated footbridge, to enable the closure of the level crossing on the A323 Guildford Road, adjacent to Ash railway station</li> <li>(10) Proposed road layout or layouts to provide connections between both the individual development sites within this site allocation and between Ash Lodge Drive and Foreman Road, providing a through road connection between Ash Lodge Drive and Foreman Road, in order to maximise accessibility and to help alleviate congestion on the A323 corridor</li> <li>(11) The loss of greenfield requires provision of sufficient integrated green infrastructure to enable connectivity of spaces and habitats between land parcels within this site, and to outside of this site</li> </ol>

	(12) Green buffer to minimise potential noise and air quality issues adjacent to the A31 and A331
Opportunities	(1) Green corridors and linkages to habitats outside of the site, ensuring that these do not increase accessibility to the Thames Basin Heaths SPA

Description	
Location	Urban area
Ward	Ash South and Tongham and Ash Wharf
Ownership	Private (multiple)
Area (size)	96 ha
Existing use	Fields
LAA reference	Site 2247
Key considerations	<ol style="list-style-type: none"> <li>(1) Loss of greenfield land</li> <li>(2) Surface water flooding</li> <li>(3) Listed buildings</li> <li>(4) Height and layout of road bridge and footbridge</li> <li>(5) Through road connection between both the individual development sites within this site and between Ash Lodge Drive and Foreman Road</li> <li>(6) Edge of urban area – transition from urban to rural</li> <li>(7) The historical location of Ash Green</li> <li>(8) A number of Tree Preservation Orders</li> <li>(9) Area of High Archaeological Potential</li> <li>(10) Adjoining ancient woodland on some boundaries</li> <li>(11) Potential noise and air quality issues</li> <li>(12) Proximity to ancient woodland/NSCI</li> </ol>

# 18/P/02308 Outline Application

**Date of Decision:** 18/02/2020

## CONDITIONS:

- 1.Expiry (3-years): [application made](#)
- 2.Implementation (2-years)
- 3.Landscape (RM)
- 4.Approved plans (std)
- 5.Housing mix
- 6.Access road (RM) (75<sup>th</sup> dwelling): [discharged \(12/05/2021\)](#)
- 7.SANG: [Agreement undertaken \(12/11/2020\)](#)
- 8.LEAP (75<sup>th</sup> dwelling)
- 9.Drainage
- 10.SUDs
- 11.Energy
- 12.SUDs Cert.
- 13.FFL
- 14.S278 works: [discharged \(14/12/2021\)](#)
- 15.Access Ash Green Road
- 16.CTMP
- 17.Junction Ash Green Road/ Foreman Road/ White Lane
- 18.Vehicle parking
- 19.EV
- 20.Travel plan
- 21.Archaeology: [part discharged \(14/06/2021\)](#)
- 22.Water efficiency
- 23.BioEco Plan

NMA: 'upto 100 dwellings' (19/01/2023)

[Previous](#)

[Next](#)

[Home](#)

## Evidence to Local Plan

(Laura Howard)

4.112 In defining the spatial strategy for the Regulation 19 Local Plan (2016), we reassessed all sites. In doing so, we also reconsidered how we could achieve sustainable development within Ash and Tongham whilst maintaining the separate identity of Ash Green village.

We still consider that Ash Green Road will functionally and visually look towards the expanded Ash and Tongham urban area once it is built, and therefore propose that this land, up to the dismantled railway, be included in the Ash and Tongham urban area instead of identified as an area of separation.

We nevertheless wish to acknowledge that this area [Ash Green Road dwellings] does form part of Ash Green village. For this reason, whilst it is proposed to be included within Ash and Tongham urban area, site allocation A29 [A31] requires that proposals for the land west of Ash Green Road should respect the historical context of this area. It also requires the provision of an **appropriate green buffer** to maintain a sense of separation between any new development and the properties along Ash Green Road

[Previous](#)

[Next](#)

[Home](#)

# Public Inquiry

## Inspector Downes (Ash Manor appeal)

It is significant to note that both Inspector Bore, and Inspector Downes (Ash Manor appeal), ‘maintains separation’ and ‘sufficient...visual break’ but does not define distance.

*(§36) ‘Coalescence is a spatial concept and would normally require a significant area of land to be effective in separating one settlement from another. No-one has suggested that this is the intention in this case, and it is not reflected in the SDF diagrams, albeit that they are illustrative. It therefore seems to me that the purpose is for a green buffer to be provided that would be sufficient as a landscape feature to provide a visual break between the proposed development area and the houses along the southern side of Ash Green Road. Whether the proposal would be successful in this respect is a matter of judgement and I return to this below.*

*(§37) ‘Policy A31(7) requires design to be sensitive at site boundaries so as to respect the transition between urban and rural. However, the appeal site is not one of the transitional sites as it adjoins allocated land to the north, east and west and Ash Green Road and its frontage housing to the south. This housing is specifically included within Ash Green village for the purposes of the policy. Furthermore, there is a small piece of allocated land to the rear of the houses fronting Ash Green Road and another development site under construction immediately to the south of the old railway line and east of White Lane. In the circumstances the area to the south of the appeal site could not properly be described as rural’.*

*(§41) ‘rear gardens... pitched roof garages would extend behind the rear building line... close boarded fences... This would not therefore be an uninterrupted green open space running along the back of the houses that would meaningfully contribute to the effectiveness of the green buffer.’*

[Previous](#)[Next](#)[Home](#)





STREET SCENE EXTRACT: PLOTS 30-34



STREET SCENE B-B EXTRACT: PLOTS 67-76

## Matter 2 (Scale & Appearance): Plots 30 – 34, 1 – 4 and 8 - 10

[Previous](#)

[Next](#)

[Home](#)

This page is intentionally left blank

**22/P/01742**

**Friars Elm  
Dog Kennel Green  
Ranmore Common  
Dorking**

[Previous](#)

[Next](#)

[Home](#)







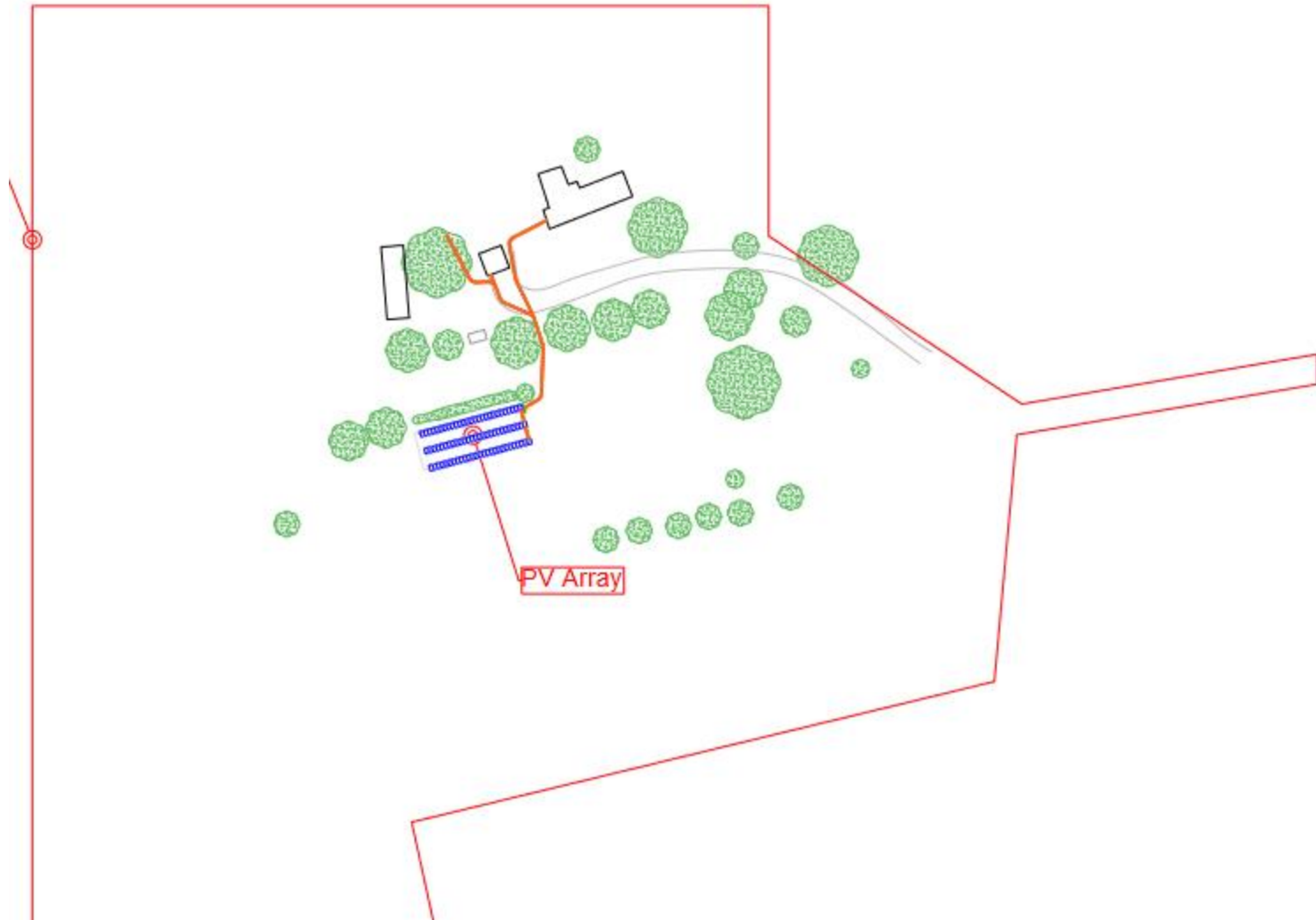

Site plan

Previous

Next

Home



### Mounting System Detail (1:40)

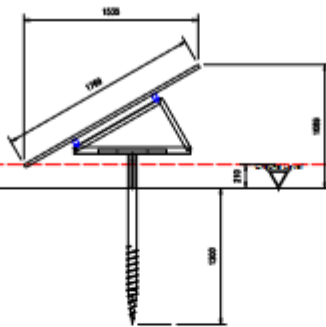

### Site Overview (1:350)

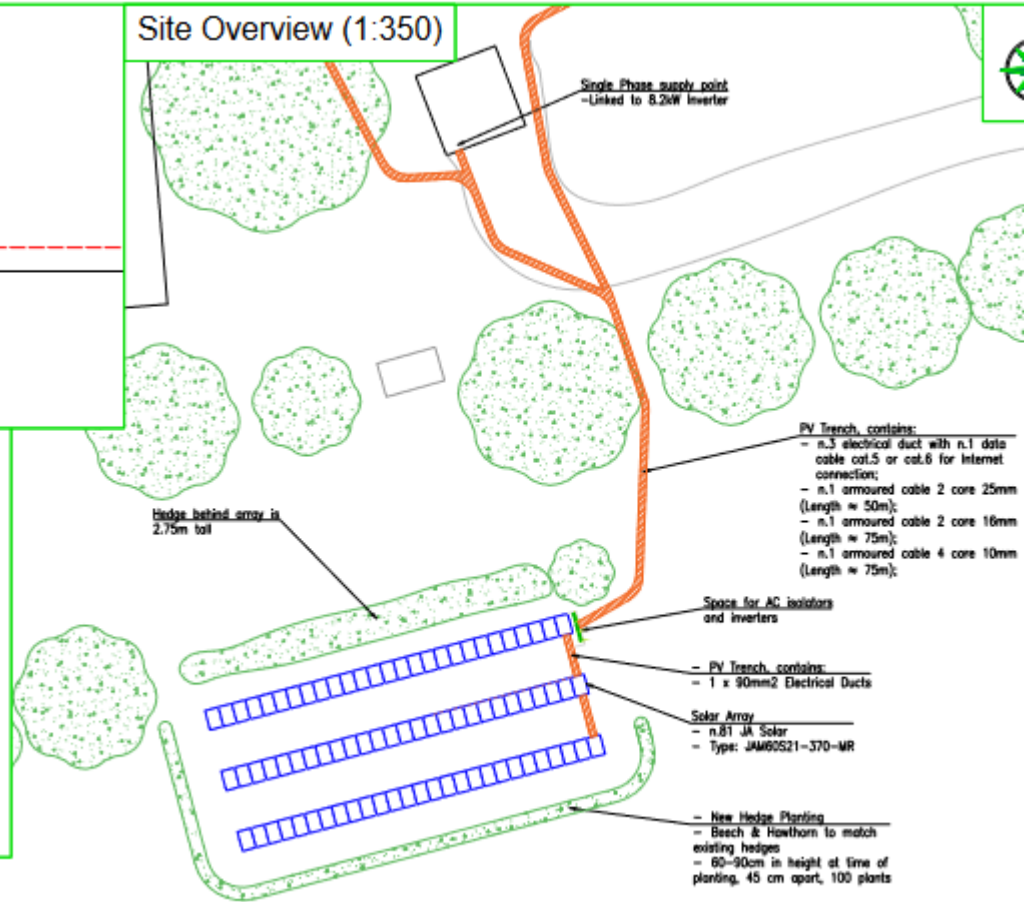

### Array Dimensions (1:250)

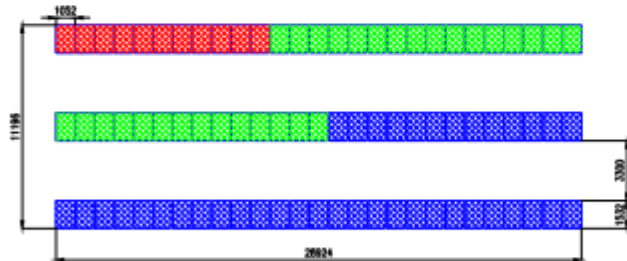

Panel connections:

Inverter 1 (3.6kW)

Inverter 2 (8.2 kW)

Inverter 3 (12.5 kW)

### Mounting System Image (NTS)





*Aerial image – location of array shown with a red star (source: Google)*

[Previous](#)

[Next](#)

[Home](#)



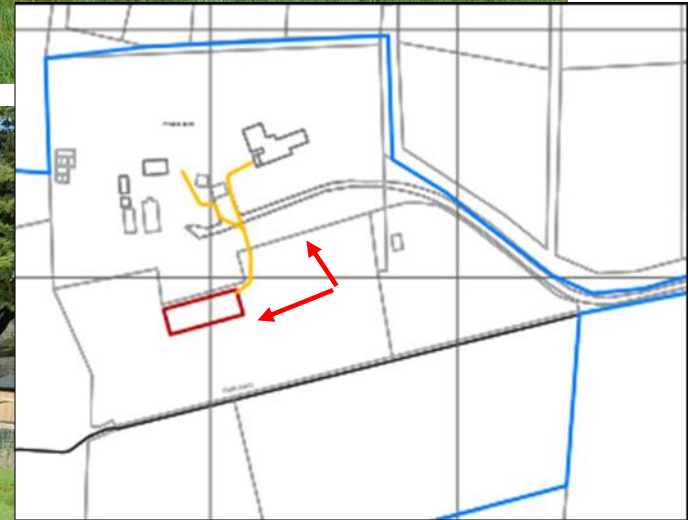

[Next](#)

[Home](#)



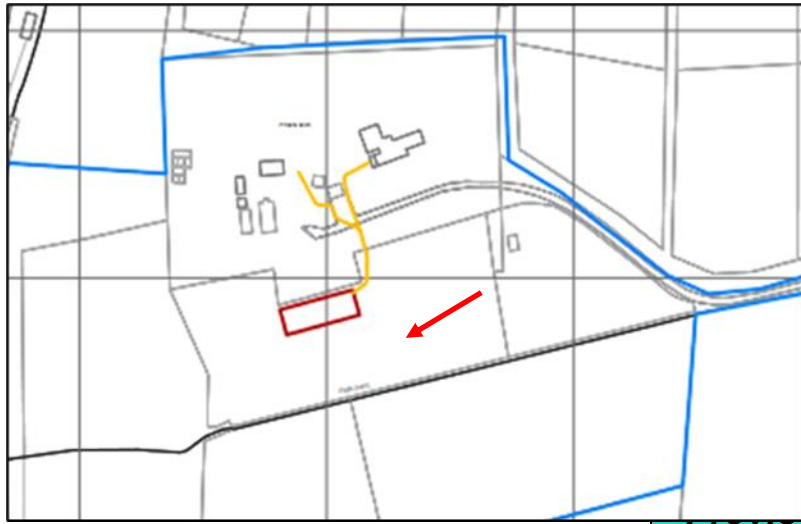

[Previous](#)

[Next](#)

[Home](#)



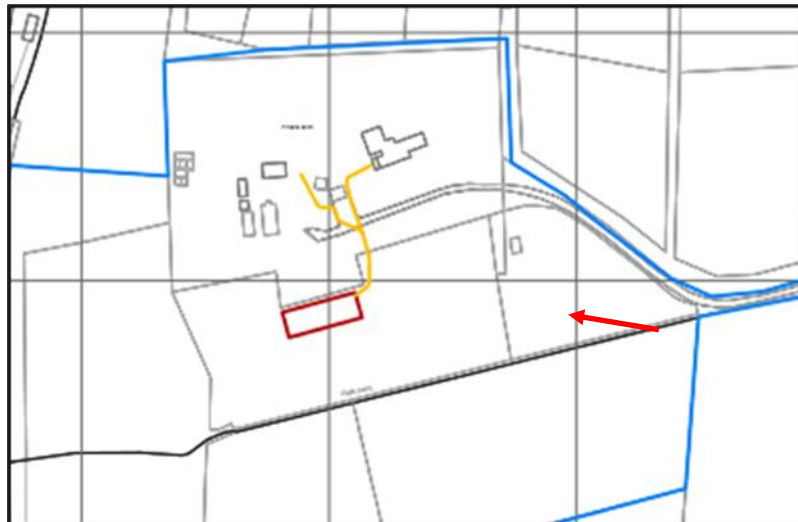

Views from public footpath

[Previous](#)

[Next](#)

[Home](#)



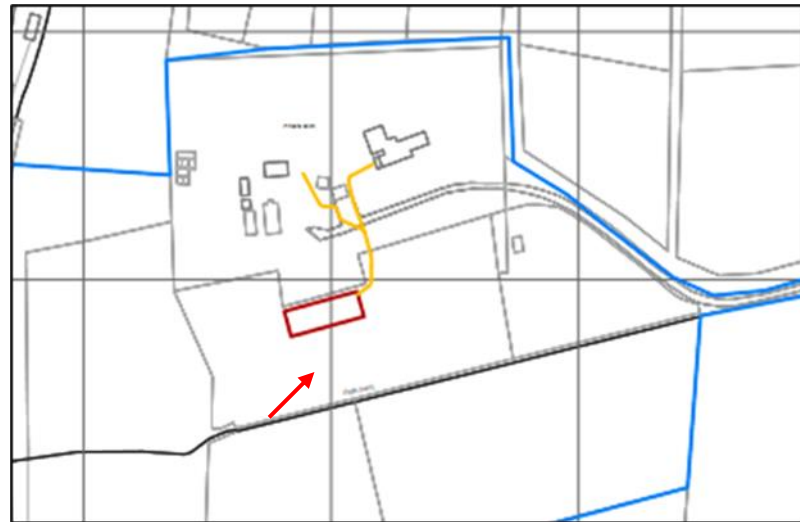

View from public footpath

[Previous](#)

[Next](#)

[Home](#)





View from public footpath

[Previous](#)

[Next](#)

[Home](#)



[Previous](#)

[Next](#)

[Home](#)

[Previous](#)

[Next](#)

[Home](#)

This page is intentionally left blank